

Micro Inverter

GW0.799K-MIS-G10

GW0.8K-MIS-G10

GW1K-MIS-G10

User Manual

Copyright Statement

Copyright ©GoodWe Technologies Co.,Ltd. 2025. All rights reserved.

No part of this manual can be reproduced or transmitted to the public platform in any form or by any means without the prior written authorization of GoodWe Technologies Co., Ltd.

Trademarks

GOODWE and other GOODWE trademarks are trademarks of GoodWe Technologies Co., Ltd. All other trademarks or registered trademarks mentioned in this manual are owned by the company.

NOTICE

The information in this user manual is subject to change due to product updates or other reasons. This guide cannot replace the notices and warnings of the device unless otherwise specified. All descriptions in the manual are for guidance only.

1. About This Manual

1.1. Overview



This manual describes the product information, installation, electrical connection, commissioning, troubleshooting, and maintenance. Read through this manual before installing and operating the product. All the installers and users have to be familiar with the product features, functions, and safety precautions. This manual is subject to update without notice. For more product details and latest documents, visit <https://en.goodwe.com/>.

1.2. Applicable Model

This manual applies to the listed inverters below:

Model	Nominal Output Power	Nominal Output Voltage
GW0.799K-MIS-G10	799W	L/N/PE, 220/230/240
GW0.8K-MIS-G10	800W	L/N/PE, 220/230/240
GW1K-MIS-G10	1000W	L/N/PE, 220/230/240

1.3. Symbol Definition

 DANGER
Indicates a high-level hazard that, if not avoided, will result in death or serious injury.
 WARNING
Indicates a medium-level hazard that, if not avoided, could result in death or serious injury.
 CAUTION
Indicates a low-level hazard that, if not avoided, could result in minor or moderate injury.
NOTICE
Highlights key information and supplements the texts. Or some skills and methods to solve product-related problems to save time.

2. Safety Precaution

Strictly follow the safety instructions in the user manual during the operation.

 WARNING
--

The products are designed and tested strictly complies with related safety rules. Read and follow all the safety instructions and cautions before any operations. Improper operation might cause personal injury or property damage as the inverters are electrical equipment.

2.1. General Safety

NOTICE

- The information in this user manual is subject to change due to product updates or other reasons. This guide cannot replace the notices and warnings of the device unless otherwise specified. All descriptions in the manual are for guidance only.
- Before installations, read through the user manual to learn about the product and the precautions.
- Use insulating tools and wear personal protective equipment when operating the equipment to ensure personal safety. Wear anti-static gloves, cloths, and wrist strips when touching electron devices to protect the inverter from damage.
- Unauthorized dismantling or modification may damage the equipment, and the damage is not covered under the warranty.
- Strictly follow the installation, operation, and configuration instructions in this manual. The manufacturer shall not be liable for equipment damage or personal injury if you do not follow the instructions.

2.2. System Safety

DANGER

- Disconnect the upstream switches to power off the equipment before any electrical connections. Do not work with power on. Otherwise, an electric shock may occur.
- All operations such as transportation, storage, installation, use and maintenance shall comply with applicable laws, regulations, standards and specifications.
- Perform electrical connections in compliance with local laws, regulations, standards and specifications, including operations, cables, and component specifications.
- Use the connectors included in the package to connect cables. The manufacturer shall not be liable for equipment damage if other connectors are used.
- Ensure all cables are connected tightly, securely, and correctly. Inappropriate wiring may cause poor connection and damage the equipment.
- To protect the equipment and components from damage during transportation, ensure that the transportation personnel are professionally trained. All operations during the transportation have to be recorded. The equipment shall be kept in balance to avoid falling down.
- Keep the equipment stable to avoid dumping, which can result in equipment damage and personal injuries.

WARNING

- Do not apply mechanical load to terminals, otherwise the terminals may be damaged.
- If the cable bears too much tension, the connection may be poor. Reserve a certain length of the cable before connecting it to corresponding ports.
- Tie the cables of the same type together, and place cables of different types at least 30mm apart. Do not place the cables entangled or crossed.
- Place the cables at least 30mm away from the heating components or heat sources, otherwise the insulation layer of the cables may be aging or broken due to high temperature.

2.2.1.PV String Safety

WARNING

- Ensure the PV module frames and the bracket system are securely grounded.
- Ensure the DC cables are connected tightly, securely and correctly. Inappropriate wiring may cause poor contacts or high impedances, and damage the inverter.
- Measure the DC cable using a multimeter to avoid reverse polarity connection. Also, the voltage should be under the max DC input voltage. The manufacturer shall not be liable for the damage caused by reverse connection and overvoltage.
- The PV strings cannot be grounded. Ensure the minimum insulation resistance of PV string to the ground meets the minimum insulation resistance requirements before connecting the PV string to the inverter ($R = \text{maximum input voltage (V)} / 30\text{mA}$).
- Do not connect one PV string to more than one inverter at the same time. Otherwise, it may cause damage to the inverter.
- PV modules used with inverters must comply with IEC 61730 Class A standard.

2.2.2.Inverter Safety







WARNING

The voltage and frequency at the connecting point should meet the on-grid requirements.

2.3.Safety Symbols and Certification Marks

DANGER

- All labels and warning marks should be visible after the installation. Do not cover, scrawl, or damage any label on the equipment.
- The following descriptions are for reference only.

No.	Symbol	Descriptions
1		Potential risks exist. Wear proper personnel protective equipment before any operations.
2		HIGH VOLTAGE HAZARD. Disconnect all incoming power and turn off the product before working on it.
3		High-temperature hazard. Do not touch the product under operation to avoid being burnt.
4		Delayed discharge. Wait 5 minutes after power off until the components are completely discharged.
5		Read through the user manual before any operations.
6		Do not dispose of the equipment as household waste. Discard the product in compliance with local laws and regulations, or send it back to the manufacturer.
7		CE mark.

2.4. EU Declaration of Conformity

2.4.1. Equipment with Wireless Communication Modules

GoodWe Technologies Co., Ltd. hereby declares that the equipment with wireless communication modules sold in the European market meets the requirements of the following directives:

- Radio Equipment Directive 2014/53/EU (RED)
- Restrictions of Hazardous Substances Directive 2011/65/EU and (EU) 2015/863 (RoHS)
- Waste Electrical and Electronic Equipment 2012/19/EU
- Registration, Evaluation, Authorization and Restriction of Chemicals (EC) No 1907/2006 (REACH)

2.4.2. Equipment without Wireless Communication Modules

GoodWe Technologies Co., Ltd. hereby declares that the equipment without wireless

communication modules sold in the European market meets the requirements of the following directives:

- Electromagnetic compatibility Directive 2014/30/EU (EMC)
- Electrical Apparatus Low Voltage Directive 2014/35/EU (LVD)
- Restrictions of Hazardous Substances Directive 2011/65/EU and (EU) 2015/863 (RoHS)
- Waste Electrical and Electronic Equipment 2012/19/EU
- Registration, Evaluation, Authorization and Restriction of Chemicals (EC) No 1907/2006 (REACH)

3. System Introduction

3.1. Product Overview

The MIS inverter is a micro single-phase grid-tied PV inverter. The inverter converts the DC power generated by the PV module into AC power and feeds it into the utility grid.

The application scenario of the inverter is plug and play PV system, as follows:

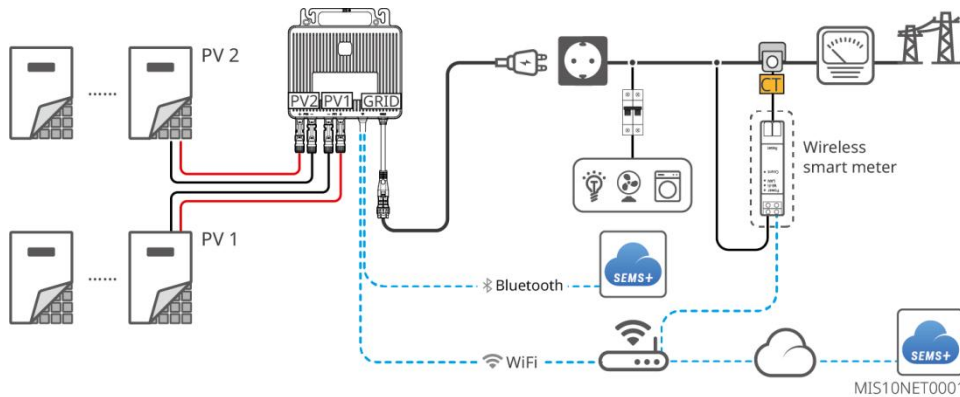

The application scenario of the inverter is hardwired system, as follows:

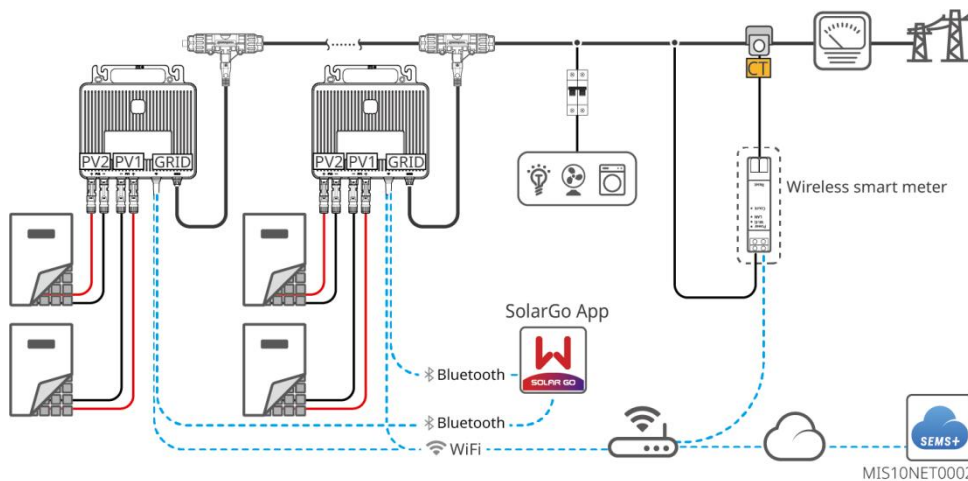

- Obtain the local grid license before connecting to the grid.
- Supports connecting one or more PV modules. Ensure the DC input from the PV system meets the following requirements: Open-circuit voltage does not exceed 60V, short-circuit current does not exceed 20A, and the power of each module is between 180Wp and 480Wp.
- The inverter supports connecting to SEMS+ App or SolarGo App(installar only) via bluetooth to configure router information. And then connecting to SEMS+ App via WiFi to realize remote monitoring and control of inverters and power stations.
- Install the smart meter or not based on actual needs. If installation is required, prepare a wireless smart meter by yourself and connect it via WiFi to enable functions such as power limitation. For installation methods and precautions regarding the wireless meter, please refer to the corresponding meter manual. Currently supported meter models: Fineco

EM115-Mod-WL (single-phase), Shelly Pro 3EM (three-phase), Eastron SEM3-WL-2 (three-phase, only for China) etc.

- When connecting a wireless smart meter in a hardwired scenario—only where local regulations permit—if multiple inverters need to be connected to a three-phase grid, ensure that CTs are installed on L1, L2, and L3, as shown in the diagram below.

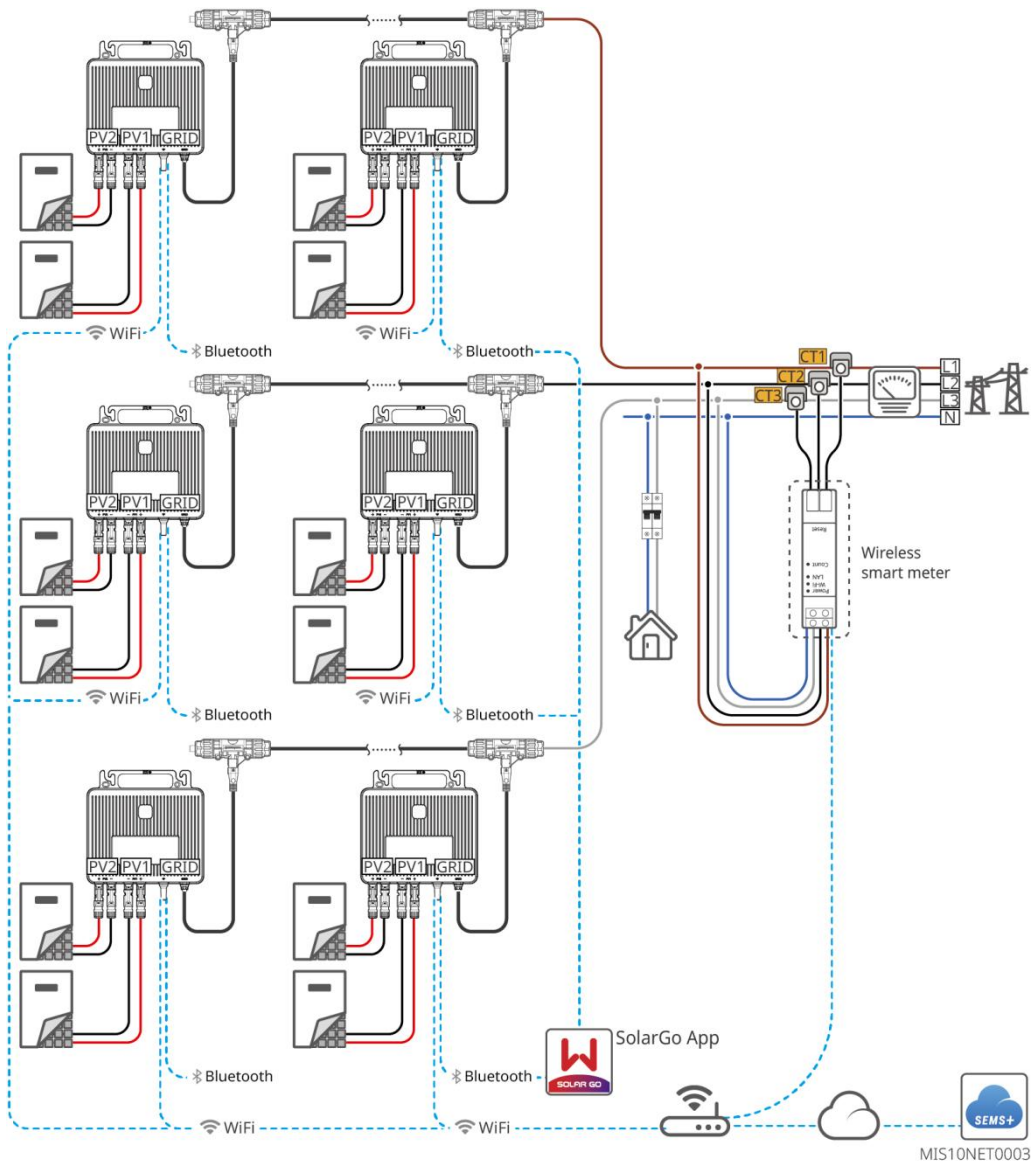

3.2. Supported Grid Types

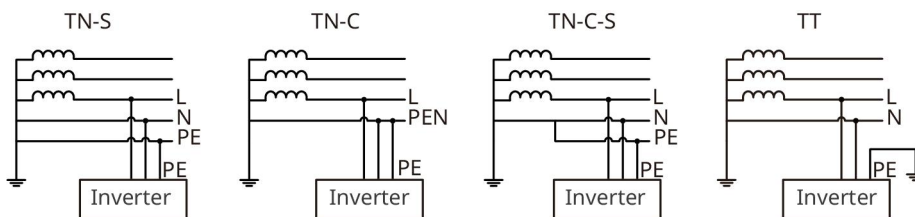

TNNET0001

3.3. Features

Power derating

To satisfying the local laws or regulations and ensuring a safe operation, the inverter will automatically reduce the output power when the operating environment is not ideal. The following are the factors that may occur power derating. Please try to avoid then during operations.

- Unfavorable environmental conditions, e.g., direct sunlight, high temperature, etc.
- Inverter's output power percentage has been set.
- Over-frequency derating.
- Higher input current value.

Communication

- Setting the inverter via bluetooth in a short distance; or connecting the inverter to the server via WiFi to monitor the inverter and power station working status.
- Bluetooth: meets Bluetooth 5.0 standard.
- WiFi: supports 2.4G frequency band. Set the router to 2.4G or 2.4G/5G mode.
- The router wireless signal name supports a maximum input of 32 bytes.
- To ensure communication quality, it is recommended to select a router with high wireless gain or more antennas. Use a wireless repeater or outdoor router if needed.

3.4. Circuit Diagram

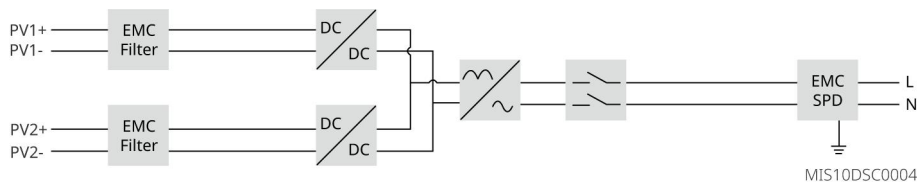

3.5. Appearance

3.5.1. Parts

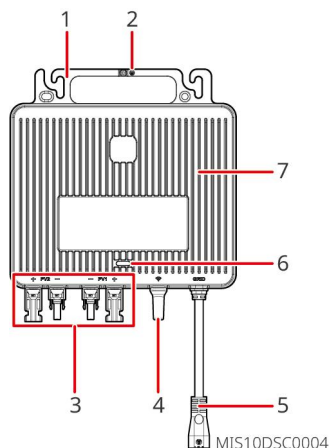

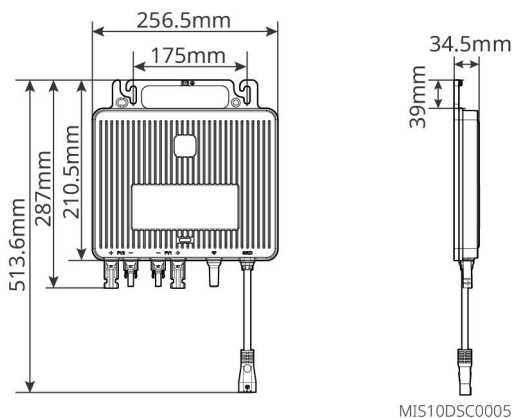

No.	Parts	Descriptions
1	Handle	Moves or hangs the inverter.
2	Grounding point	Connects the grounding cable to the grounding points for protection. If the AC plug is grounded, no additional grounding cable is required.
3	PV connector	Connects the inverter to the PV module. Connector model: MC4.
4	Antenna	Wireless communication; supports WiFi/bluetooth.
5	AC connector	Connects the AC cable to provide AC output power to household loads.
6	LED indicator	Indicates working state of the inverter.
7	Heat sink	Used for heat dissipation of inverters.

3.5.2. Dimensions



3.5.3. Indicators

Indicator status	Descriptions
	Slow blinking green = Equipment on and in the standby mode.
	Fast blinking green = equipment starting and in the self-check mode.
	Steady green = The two PV inputs are available, and the inverter is feeding power to the grid properly.
	Blinking green and red = Not all PV inputs are available, but the inverter is still feeding power to the grid. The two blinks represent the status of PV1 and PV2 respectively. A red blink indicates abnormal PV input, and a green blink indicates

	normal PV input. Example: As shown on the left, PV1 is abnormal, and PV2 is working normally.
	Double blinking red = Utility grid fault.
	Steady red = Equipment fault.
	Fast blinking green and red = Updating software.

3.5.4.Nameplate

The nameplate is for reference only.

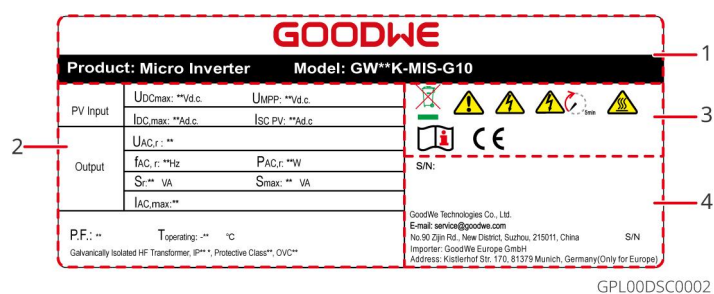

GPL00DSC0002

No.	Descriptions
1	GW trademark, product type, and product model.
2	Technical parameters.
3	Safety symbols and certification marks.
4	Contact information and serial number.

4. Check and Storage

4.1. Check Before Receiving





Check the following items before accept the product.

- Check the outer packing box for damage, such as holes, cracks, deformation, and other signs of equipment damage. Do not unpack the package and contact the supplier as soon as possible if any damage is found.
- Check the product model. If the product model is not what you requested, do not unpack the product and contact the supplier.
- Check the deliverables for correct model, complete contents, and intact appearance. Contact the supplier as soon as possible if any damage is found.

4.2. Package Content

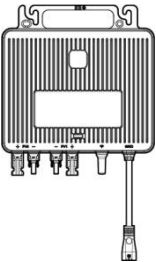
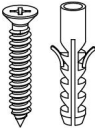
NOTICE

- Connect the PV cables using the connectors in correct model. The manufacturer shall not be liable for the damage if other connectors are used.
- The actual number of accessories may differ.
- The optional accessories can be purchased from the manufacturer based on your actual needs. The accessories will be delivered separately. The actual number of accessories may differ.



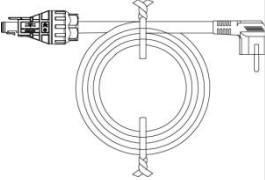

Parts	Descriptions	Parts	Descriptions
	Inverter x 1		Expansion screws x 2
	Flange nuts x 1		Assembly bolts x 2
	PV fastening tool x 4		Unlock tool for PV and AC connectors x 1

	Documents x 1		
---	---------------	--	--

For plug and play systems, AC connector and cables should be purchased separately, as following:

Parts	Descriptions	Parts	Descriptions
	AC cable AC cable length: 5m, 10m, or 15m. Only for the plug and play scenario.	-	-

For hardwired installations, AC connectors and cables should be purchased separately. The quantities listed below are for reference only, actual accessory requirements may vary.

Parts	Descriptions	Parts	Descriptions
	T-shape AC connector with cable x 1 Number of the connector and number of the inverter are the same.		The quantity of connectors matches the number of inverters.
	Unlock tool for PV connectors x N		PIN terminal x N
	Unlock tool for T-shape AC connectors x N	-	-

4.3.Storage

If the equipment is not to be installed or used immediately, please ensure that the storage environment meets the following requirements:

1. Do not unpack the outer package.
2. Store the equipment in a clean place. Make sure the temperature and humidity are appropriate and there is no condensation.
3. The height and direction of the stacking products should follow the instructions on the packing box.

4. The product must be stacked with caution to prevent them from falling.
5. If the inverter has been stored for more than two years or has not been in operation for more than six months after installation, it is recommended to be inspected and tested by professionals before being put into use.
6. To ensure good electrical performance of the internal electronic components of the inverter, it is recommended to power it on every 6 months during storage. If it has not been powered on for more than 6 months, it is recommended to to be inspected and tested by professionals before being put into use.

5. Installation

5.1. Installation Requirements

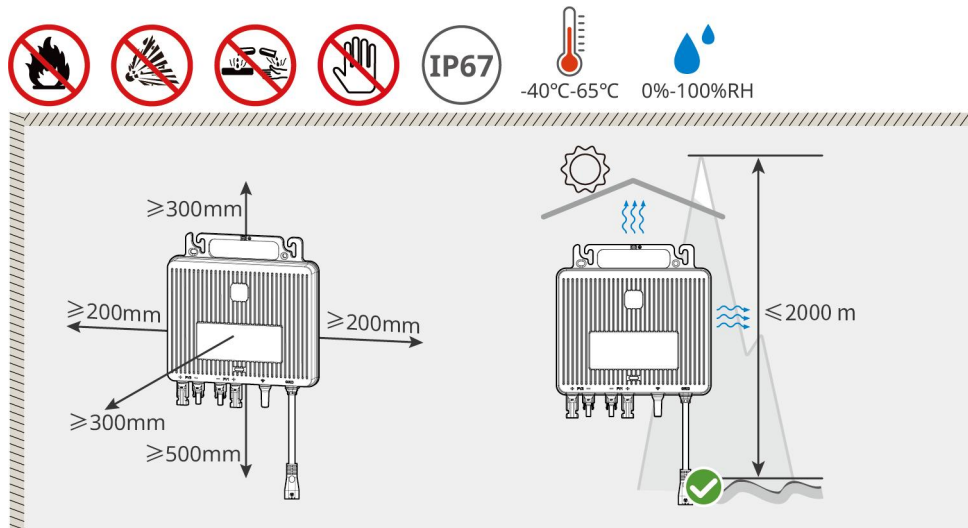

Installation Environment Requirements

- Do not install the equipment in a place near flammable, explosive, or corrosive materials.
- The temperature and humidity at the installation site should be kept within the appropriate range.
- Do not install the equipment in a place that is easy to touch, especially within children's reach.
- When the equipment is working, its temperature may be high. Do not touch the surface to avoid burn.
- Install the equipment in a sheltered place to avoid direct sunlight, rain, and snow.
- The place to install the equipment shall be well-ventilated for heat radiation and large enough for operations.
- Install the equipment at a height that is convenient for operation and maintenance, electrical connections, and check indicators and labels.
- The altitude to install the equipment shall be lower than the maximum working altitude of the system.













Mounting Support Requirements

- The mounting support shall be nonflammable and fireproof.
- Ensure the mounting support is solid enough to bear the inverter weight.

Installation Tool Requirements

The following tools are recommended when installing the equipment. Use other auxiliary tools on site if necessary.

Tool	Descriptions	Tool	Descriptions
------	--------------	------	--------------

	Goggles		Safety shoes
	Safety gloves		Dust mask
	Socket wrench set M8		Impact drill
	Marker		Level
	Torque wrench M6		Rubber hammer
	Cable tie		Vacuum cleaner
	Multimeter	-	-

5.2. Installing the Inverter



Move the equipment to the site before installation. Follow the instructions below to avoid personal injury or equipment damage.

1. Do not bump or hit the antenna. Otherwise, the antenna may be damaged.
2. Instead of lifting the cables directly, it is recommended to hold the handle of the inverter to prevent potential damage to the cables.

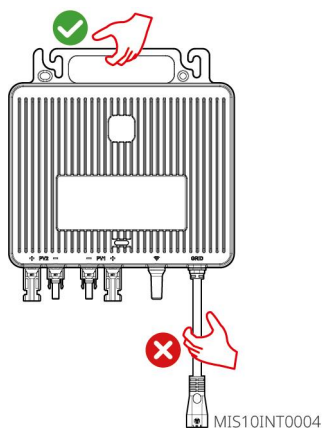

NOTICE

- For plug and play installation, plan the installation position reasonably and make sure the cable lengths between the inverter, PV and socket are sufficient.
- For hardwired installation, consider the AC cable length and plan the installation position reasonably.

Wall installation

Step 1 Confirm the installation location based on the layout plan, and mark the drilling positions with a marker pen.

Step 2 Drill holes at the marked positions, then install the expansion screws. Hole diameter: 8mm. Hole depth: 45mm.

Step 3 Hang the inverter onto the expansion screws and tighten the screws with a torque wrench.

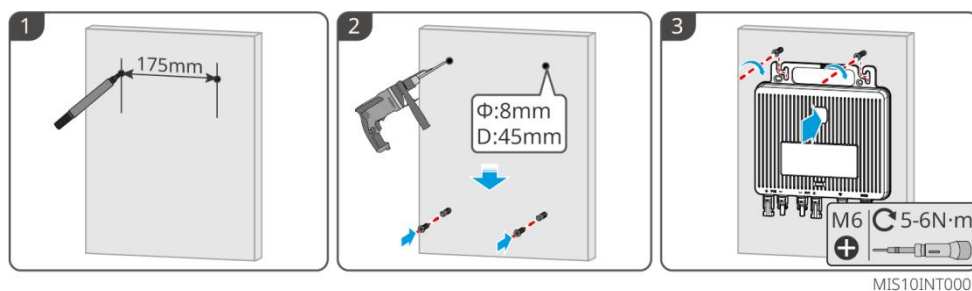

PV Rail Mounting

Step 1 Prepare the PV rails that meet the required specifications, and confirm the installation location according to the layout plan.

Step 2 Insert the assembly bolts into the PV rail from the side.

Step 3 Hang the inverter onto the assembly bolts and tighten the flange nuts using a socket wrench.

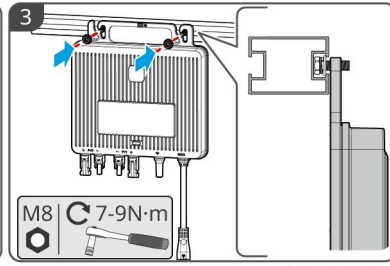
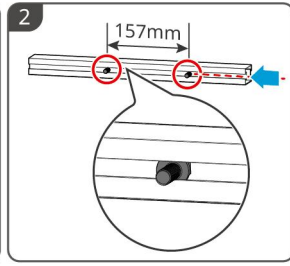
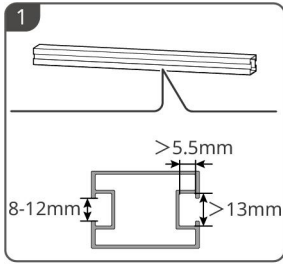

MIS10INT0002

6. Electrical Connection

6.1. Connecting the PE Cable (Hardwired Scenario)

When multiple inverters are installed in a hardwired scenario, the PE cable should be connected to ensure system safety.



1. Ensure that the equipment is reliably grounded before operations.
2. To improve the corrosion resistance of the terminal, you are recommended to apply silica gel or paint on the ground terminal after installing the PE cable.
3. The PE cable, grounding OT terminal and screw should be prepared by the customer.

Recommended specifications:

- PE cable: outdoor copper cable, conductor cross-sectional area: 6mm^2 .
- OT terminal: M4
- Screw: M4

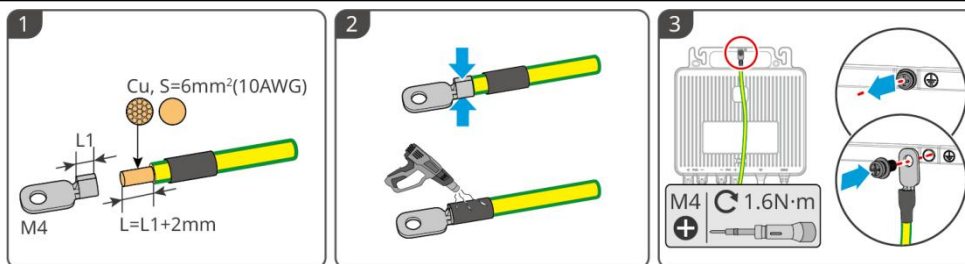

6.2. Connecting PV cables



- Ensure the PV connectors are connected with correct polarity.
- To prevent PV cables from disconnecting, install the PV fastening tool. The fastening tool is only suitable for MC4 PV connectors.

Step 1 Take out the PV fastening tool included in the package and install it onto the PV connector of the inverter.

Step 2 Plug the PV connector of the PV module into the PV connector of the inverter.

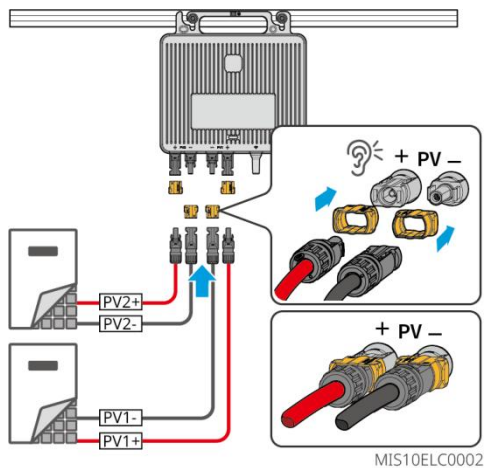

6.3. Connecting the AC Cable

- Scenario 1: plug and play



DANGER

Ensure the AC plug matches the specifications of the socket.

Step 1 Insert the AC cable included in the package into the AC connector of the inverter.

Step 2 Plug the other end of the cable into the household socket. The inverter will power on and start working.

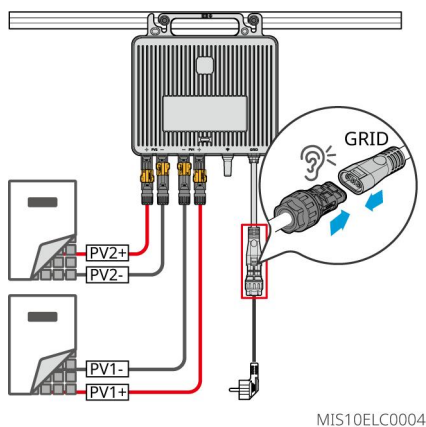

- Scenario 2: hardwired

NOTICE

- The AC cable assembly includes 21 T-type connectors as standard. Before use, split the AC cable according to the number of inverters, ensuring the retained T-type connectors match the inverter count.
- The included AC cable has pre-cut segments at 2.5m intervals. If this length is insufficient, prepare additional compliant AC cables.

For extended cabling needs, refer to local regulations and the table below to source approved AC cable extensions.

T-shape connector AC cable specification (AC cable specification)	Maximum number per branch
10AWG	8
12AWG	6
14AWG	4

Step 1: Take out the AC cable and verify the required number of T-shape connectors. **Step 2:** Use the included connector unlock tool to detach the terminal T-type connector from the AC cable.

Loosen the internal screw of the detached T-type connector.

Step 2: Remove the crimped AC cable from the connector.

Step 3: The included AC cable has a fixed segment length of 2.5m. If the length is sufficient, directly connect the terminal AC cable to the distribution box. If extended length is required, replace the terminal cable with a user-provided compliant extension, then connect it to the T-type connector before linking to the distribution box.

Step 4: Attach the inverter-side AC connectors to the corresponding T-shape connectors on the AC cable sequentially.

Step 5: Install the waterproof plug at the end of the starting T-shape connector.

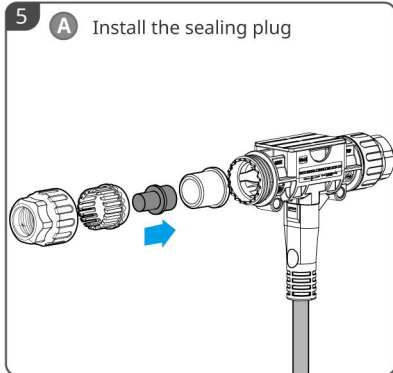
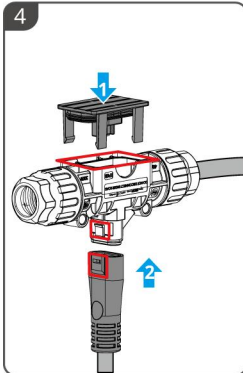
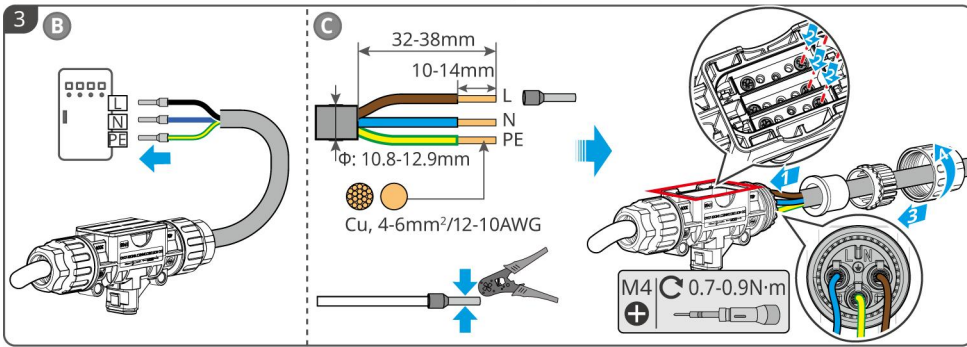
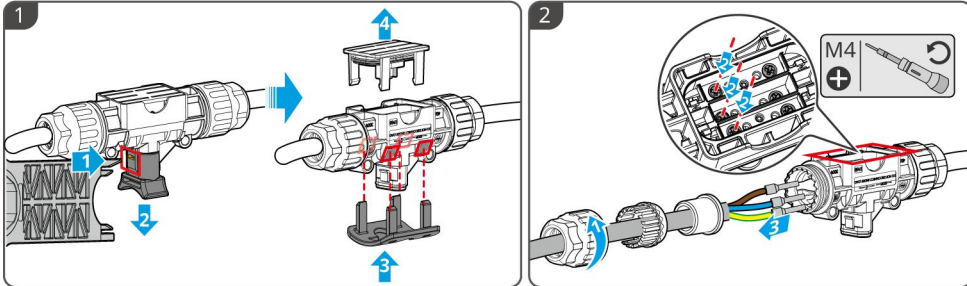
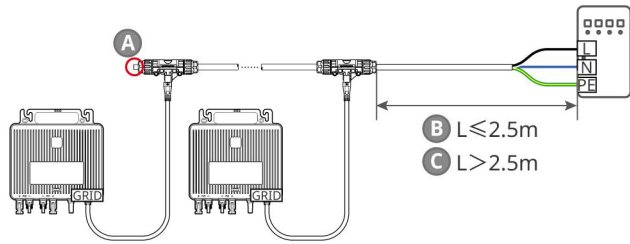

MIS10ELC003

7. System Trial Operation

7.1. Check Before Power ON

No.	Check Item
1	The inverter is firmly installed in a clean place where is well-ventilated and easy to operate.
2	The PE, DC input and AC output cables are connected correctly and securely.
3	Cable ties are intact, routed properly and evenly.
4	Unused cable holes are sealed.
5	The voltage and frequency at the connecting point should meet the on-grid requirements.

7.2. Power ON

A. Plug and play scenario: complete all electrical connections and plug the AC power cord directly into a standard household outlet.

B. Hardwired scenario: complete all electrical connections, energize the system by connecting the AC circuit breaker in the distribution panel.

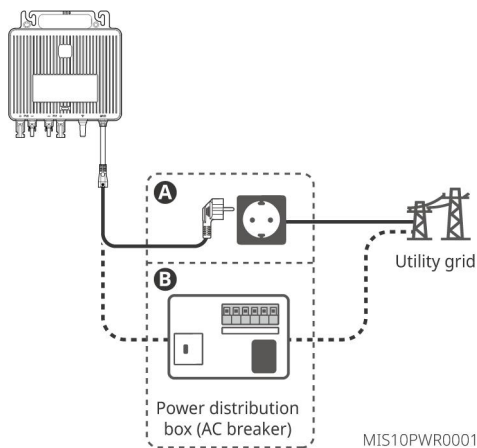

8. System Commissioning and Plant Monitoring

The SEMS+App enables remote monitoring of power stations and local configuring devices. Installers and owners can:

- Conduct remote monitoring and configure parameters at both the station and device level.
- Establish a local connection to devices to review operational status and adjust settings.

Downloading and installing SEMS+ App

Make sure that the mobile phone meets the following requirements:

- Operating system:Android7.0 or above, iOS 15.1 or above.
- Internet connection via browser.
- WLAN/Bluetooth capabilities.

Download Methods:

Method I

Search SEMS+ on Google Play, App Store, Huawei, Honor, Xiaomi, OPPO,vivo app store to download and instal the App.



Method II

Scan the QR code below to download and install the App.

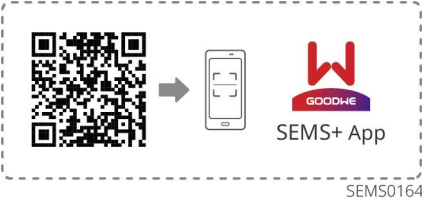

For details, refer to the '[SEMS+ User Manual](#)'. The user manual can be obtained from the official website or by scanning the QR code below.



SEMS+ App User Manual

9. System Maintenance

9.1. Power Off

NOTICE

To reset the bluetooth password, power off the inverter and wait for 20-30s, then power it back on.

A. Plug and play scenario: unplug the AC plug from the household outlet.

B. Hardwired scenario: turn off the AC circuit breaker in the distribution panel.

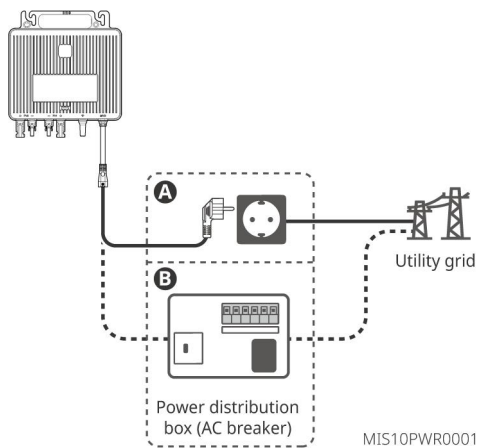

9.2. Removing the Inverter

! WARNING

- Make sure that the inverter is powered off.
- Wear proper PPE before any operations.

Step 1 Disconnect all the cables, including PV cable and AC cables.

Step 2 Remove the inverter.

Step 3 Store the inverter properly. If the inverter needs to be used later, ensure that the storage conditions meet the requirements.

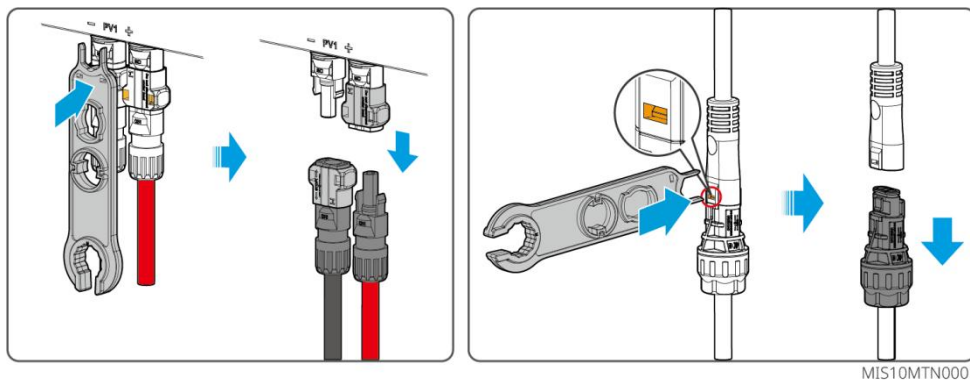

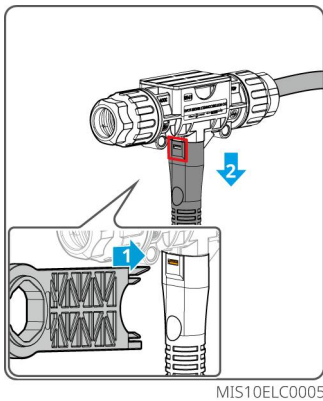

9.3. Disposing of the Inverter

If the inverter cannot work anymore, dispose of it according to the local disposal requirements for electrical equipment waste. The inverter cannot be disposed of together with household waste.

9.4. Routine Maintenance

DANGER

- Before maintaining the equipment, take necessary protective measures to prevent electric shock.
- During maintenance, ensure that both upstream and downstream switches of the equipment are disconnected.
- Strictly follow proper operating procedures during maintenance.

WARNING

- Contact after-sales service for help if the copper conductor is exposed. Do not touch or disassemble privately because high voltage danger exists.
- In case of other emergencies, contact the after-sales service as soon as possible. Operate following the instructions or wait for the after-sales service personnel.

Maintaining Item	Maintaining Method	Maintaining Period	Maintaining Purpose
System Clean	Check whether the installation space meets requirements and whether there is any debris around the device.	Once half a year	Prevent heat dissipation failures.
System installation	1. Check whether the equipment are	Once 6-12 months	Ensure that the equipment is

	<p>installed securely and whether the screws are installed tightly.</p> <p>2. Check whether the equipment is damaged or deformed.</p>		installed securely.
Electrical connection	<p>Check whether the cables are securely connected.</p> <p>Check whether the cables are broken or whether there is any exposed copper core.</p>	Once 6-12 months	Confirm the reliability of electrical connections.

9.5. Troubleshooting

Perform troubleshooting according to the following methods. Contact the after-sales service if these methods do not work.

Collect the information below before contacting the after-sales service, so that the problems can be solved quickly.

1. Product information like serial number, software version, installation date, fault time, fault frequency, etc.
2. Installation environment, including weather conditions, whether the PV modules are sheltered or shadowed, etc. It is recommended to provide some photos and videos to assist in analyzing the problem.
3. Utility grid situation.

No.	Fault	Cause	Solutions
1	Grid Overvoltage	The grid voltage exceeds the permissible range, or the duration of high voltage exceeds the requirement of HVRT.	<ol style="list-style-type: none"> 1. If the problem occurs occasionally, the utility grid may be abnormal temporarily. The inverter will recover automatically after detecting that the utility grid is normal. 2. If the problem occurs frequently, check whether the grid voltage is within the permissible range. 3. Check whether the AC breaker and the output cables are connected securely and

			correctly if the problem persists.
2	Grid Undervoltage	The grid voltage is lower than the permissible range, or the duration of low voltage exceeds the requirement of LVRT.	<ol style="list-style-type: none"> 1. If the problem occurs occasionally, the utility grid may be abnormal temporarily. The inverter will recover automatically after detecting that the utility grid is normal. 2. If the problem occurs frequently, check whether the grid voltage is within the permissible range. 3. Check whether the AC breaker and the output cables are connected securely and correctly if the problem persists.
3	Grid Overfrequency	Utility grid exception. The actual grid frequency exceeds the requirement of the local grid standard.	<ol style="list-style-type: none"> 1. If the problem occurs occasionally, the utility grid may be abnormal temporarily. The inverter will recover automatically after detecting that the utility grid is normal. 2. If the problem occurs frequently, check whether the grid frequency is within the permissible range.
4	Grid Underfrequency	Utility grid exception. The actual grid frequency is lower than the requirement of the local grid standard.	<ol style="list-style-type: none"> 1. If the problem occurs occasionally, the utility grid may be abnormal temporarily. The inverter will recover automatically after detecting that the utility grid is normal. 2. If the problem occurs

			frequently, check whether the grid frequency is within the permissible range.
5	Grid Rapid Overvoltage	The grid voltage is abnormal or ultra high.	<ol style="list-style-type: none"> 1. If the problem occurs occasionally, the utility grid may be abnormal temporarily. The inverter will recover automatically after detecting that the utility grid is normal. 2. If the problem occurs frequently, check whether the grid voltage is within the permissible range. 3. Check whether the AC breaker and the output cables are connected securely and correctly if the problem persists.
6	Grid 10min Overvoltage	The moving average of grid voltage in 10min exceeds the range of safety requirements.	If the problem occurs frequently, check whether the grid frequency is within the permissible range. If not, contact the local power company.
7	孤岛保护 Anti-islanding	The utility grid is disconnected. The utility grid is disconnected according to the safety regulations, but the grid voltage is maintained due to the loads.	<ol style="list-style-type: none"> 1. If the problem occurs occasionally, the utility grid may be abnormal temporarily. The inverter will recover automatically after detecting that the utility grid is normal. 2. If the problem occurs frequently, check whether the grid frequency is within the permissible range.
8	LVRT	Utility grid exception. The duration of the utility grid	<ol style="list-style-type: none"> 1. If the problem occurs occasionally, the utility grid

	Undervoltage	exception exceeds the set time of HVRT.	<p>may be abnormal temporarily. The inverter will recover automatically after detecting that the utility grid is normal.</p> <p>2. If the problem occurs frequently, check whether the grid voltage and frequency are within the permissible range. If not, contact the local power company.</p>
9	HVRT Overvoltage	Utility grid exception. The duration of the utility grid exception exceeds the set time of HVRT.	<p>3. If the problem occurs occasionally, the utility grid may be abnormal temporarily. The inverter will recover automatically after detecting that the utility grid is normal.</p> <p>4. If the problem occurs frequently, check whether the grid voltage and frequency are within the permissible range. If not, contact the local power company.</p>
10	Level1 DCI abnormal	The DC component of the output current exceeds the safety range or default range.	<p>1. If the problem is caused by an external fault like a utility grid exception or frequency exception, the inverter will recover automatically after solving the problem.</p> <p>2. If the problem occurs frequently and the PV station cannot work properly, contact the dealer or the after-sales service.</p>
11	Level2 DCI abnormal		
12	Low	<p>1. The PV string is short-circuited to PE.</p> <p>2. The PV system is in a moist</p>	<p>1. Check whether the resistance of the PV string to PE exceeds 50kΩ. If no, check the short</p>

	Insulation Res.	environment and the cable is not well insulated to the ground.	circuit point. 2. Check whether the PE cable is connected correctly.
13	Flash R/W abnormal	The internal Flash storage is abnormal.	Disconnect the AC output switch and DC input switch, then connect them 5 minutes later. Contact the dealer or the after-sales service if the problem persists.
14	Cavity Overtemperature	<ol style="list-style-type: none"> 1. The installation location of the inverter is not ventilated. 2. The ambient temperature exceeds 60°C. 3. Internal fan working abnormally 	<ol style="list-style-type: none"> 1. Check whether the ventilation of the inverter installation location is good and whether the ambient temperature exceeds the maximum allowable ambient temperature range. 2. If the ventilation is poor or the ambient temperature is too high, improve the ventilation and heat dissipation conditions. 3. Contact the dealer or after-sales service if both the ventilation and the ambient temperature are normal.
15	PV Input Overvoltage	The PV array configuration is not correct. Too many PV panels are connected in series in the PV string.	Check the serial connection of the PV array. Make sure that the open circuit voltage of the PV string is not higher than the maximum operating voltage of the inverter.
16	PV Continuous Hardware Overcurrent	<ol style="list-style-type: none"> 1. The PV configuration is not proper. 2. The hardware is damaged. 	Disconnect the AC output switch and DC input switch, then connect them 5 minutes later. Contact the dealer or the after-sales service if the problem persists.
17	PV Continuous Software Overcurrent	<ol style="list-style-type: none"> 3. The PV configuration is not proper. 4. The hardware is damaged. 	Disconnect the AC output switch and DC input switch, then connect them 5 minutes later. Contact the dealer or the after-sales service if the problem persists.
18		The PV strings are connected	Check whether the PV strings are

	PV String Reversed	reversely.	connected reversely.
19	MOS once Overvoltage	<ol style="list-style-type: none"> 1. The MOS is abnormal. 2. The PV voltage is too high. 3. The MOS voltage sampling is abnormal. 	Disconnect the AC output switch and PV cables, then connect them 5 minutes later. Contact the dealer or the after-sales service if the problem persists.
20		A sudden change in the grid or load causes an overcurrent.	Contact the dealer or the after-sales service if the problem persists.

10. Technical Parameters

Technical parameters	GW0.799K-MIS-G10	GW0.8K-MIS-G10	GW1K-MIS-G10
Input			
Max. Input Power (W)	960	960	1350
Max. Input Voltage (V)	60	60	60
Nominal Input Voltage (V)	42	42	42
Min. Start-up Voltage (V)	15	15	15
MPPT Operating Voltage Range (V)	13-60	13-60	13-60
Max. Input Current (A)	18/18	18/18	18/18
Max. Input Short Circuit Current (A)	20/20	20/20	20/20
Number of MPP Trackers	2	2	2
Number of Strings per MPPT	1	1	1
Output			
Nominal Output Power (W)	799	800	1000
Max. Continuous Output Power (W)	799	800	1000
Nominal Apparent Power (VA)	799	800	1000
Max. AC Apparent	799	800	1000

Power (VA)			
Nominal Output Voltage (V)	L/N/PE, 220/230/240	L/N/PE, 220/230/240	L/N/PE, 220/230/240
Output Voltage Range (V)	176 - 264	176 - 264	176 - 264
Nominal Output Frequency (Hz)	50/60	50/60	50/60
AC Grid Frequency Range (Hz)	50/60 ±5	50/60 ±5	50/60 ±5
Max. Continuous Output Current (A)	3.50 @220 V 3.47 @230 V 3.33 @240 V	3.50 @220 V 3.48 @230 V 3.33 @240 V	4.54 @220 V 4.35 @230 V 4.17 @240 V
Power Factor (@nominal power)	~1 default -0.8 leading ... +0.8 lagging adjustable	~1 default -0.8 leading ... +0.8 lagging adjustable	~1 default -0.8 leading ... +0.8 lagging adjustable
Max. Total Harmonic Distortion	< 3%	< 3%	< 3%
Efficiency			
Max. Efficiency	96.4%	96.4%	96.4%
European Weighted Efficiency	94.0%	94.0%	94.0%
Nominal MPPT efficiency	99.8%	99.8%	99.8%
General Data			
Operating Temperature Range (°C)	-40°C ~ 65°C (Derating temperature 45°C)	-40°C ~ 65°C (Derating temperature 45°C)	-40°C ~ 65°C (Derating temperature 45°C)
Relative	0~100%	0~100%	0~100%

Humidity			
Max. Operating Altitude (m)	0~2000	0~2000	0~2000
Cooling Method	Natural convection	Natural convection	Natural convection
Weight (kg)	3.3kg	3.3kg	3.3kg
Dimensions (W×H×D mm)	256 × 210 × 34	256 × 210 × 34	256 × 210 × 34
Ingress Protection Rating	IP67 C4M	IP67 C4M	IP67 C4M
Overvoltage Category	DC II / AC III	DC II / AC III	DC II / AC III
Features			
Communication	Built-in Wi-Fi and Bluetooth	Built-in Wi-Fi and Bluetooth	Built-in Wi-Fi and Bluetooth
Monitoring	SEMS+ APP	SEMS+ APP	SEMS+ APP
Protection	PV Insulation Resistance Detection, PV Reverse Polarity Protection, Anti islanding Protection, AC Overcurrent Protection, AC Short Circuit Protection, AC Overvoltage Protection, Type III AC Surge Arrester		
Warranty	12 Years Standard, 25 Years Optional	12 Years Standard, 25 Years Optional	12 Years Standard, 25 Years Optional
Topology	Galvanically Isolated HF Transformer	Galvanically Isolated HF Transformer	Galvanically Isolated HF Transformer
Compliance	IEC62109, VDE 0126-95, VDE 4105:2018, EN 50549-1:2019+EN 50549-10, ETSI/EN 303645, EN 18031, IEC61000, EN300328, EN301489, EN IEC 62311, IEC62920		

11. Appendix

11.1. Term Explanation

Overvoltage category definition

Category I: Applies to equipment connected to a circuit where measures have been taken to reduce transient overvoltage to a low level.

Category II: Applies to equipment not permanently connected to the installation. Examples are appliances, portables tools and other plug-connected equipment.

Category III: Applies to a fixed equipment downstream, including the main distribution board. Examples are switchgear and other equipment in an industrial installation.

Category IV: Applies to equipment permanently connected at the origin of an installation (upstream of the main distribution board). Examples are electricity meters, primary over-current protection equipment and other equipment connected directly to outdoor open lines.

Moisture location category definition

Environmental Parameters	Level		
	3K3	4K2	4K4H
Moisture Parameters	0~+40°C	-33~+40°C	-33~+40°C
Temperature Range	15% - 85%	15% - 100%	4% - 100%

Environment category definition

Outdoor: Ambient Temperature: -25~+60°C, applied to Pollution Degree 3 environment.

Indoor Unconditioned: Ambient Temperature: -25~+40°C, applied to Pollution Degree 3 environment.

Indoor conditioned: Ambient Temperature: 0~+40°C, applied to Pollution Degree 2 environment.

Pollution degree definition

Contamination Class I: No contamination or only dry, non-conductive contamination;

Pollution Degree II: Normally only non-conductive pollution occurs. Occasionally, however, a temporary conductivity caused by condensation must be expected.

Pollution Degree III: Conductive pollution occurs, or dry, non-conductive pollution occurs, which becomes conductive due to condensation, which is expected.

Pollution Degree IV: Persistent conductive pollution occurs, for example, the pollution caused by conductive dust, rain or snow.





GoodWe official website

GoodWe Technologies Co., Ltd.

 No. 90 Zijin Rd., New District, Suzhou, 215011, China

 T: 400-998-1212

 www.goodwe.com

 service@goodwe.com



Local Contact